



The affordable LEDspot solution

CorePro LEDspot LV

CorePro LEDspots are a perfect fit for spot lighting and deliver warm halogen-like light. They are compatible with most existing fixtures with MR16 GU5.3 holders and are designed as a retrofit replacement for halogen or incandescent spots. CorePro LEDspots deliver huge energy savings and minimize maintenance cost.

Benefits

- Up to 80% energy saving compared with halogen lamps
- Lower maintenance costs
- Broad compatibility with transformers

Features

- Easy retrofit
- Lifetime of 15,000hours
- UV- and IR-free light
- Free of mercury and hazardous materials

Application

- Hotels, restaurants, bars, cafés, museums, shops
- Lobbies, corridors, stairwells, washrooms, reception areas , exhibitions, display cabinets

CorePro LEDspot LV

Versions



GU4 MR11



GU5.3 MR16



GU5.3 MR16



LEDspot GU5.3 MR16



GU4 1.375inch/35mm



GU5.3 2inch/50mm

Dimensional drawing

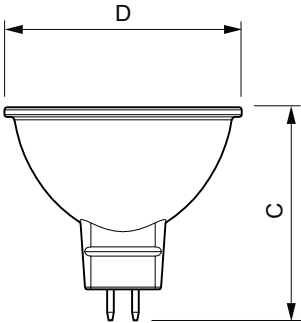

Product	D	C
CorePro LED spot 2.6–20W 827 MR11 36D	35 mm	37.5 mm
CorePro LED spot ND 3–20W MR16 827 36D	51 mm	46 mm
CorePro LED spot ND 5–35W MR16 827 36D	51 mm	46 mm
CorePro LED spot ND 5–35W MR16 840 36D	51 mm	46 mm
CorePro LED spot ND 7–50W MR16 827 36D	50.5 mm	45 mm
CorePro LED spot ND 7–50W MR16 840 36D	50.5 mm	45 mm
CorePro LED spot ND 7–50W MR16 830 36D	50.5 mm	45 mm
CorePro LEDspot 5–35W MR16 827 36D 5CT	51 mm	46 mm
LED 20W MR11 GU4 WW ND RF 1BC/6	35 mm	37.5 mm
LED 20W MR11 GU4 WW ND 1SRT4	35 mm	37.5 mm
CorePro LED spot ND 2.9–20W MR16 827 36D		
CorePro LEDspot 4.4–35W MR16 827 36D 5CT		
CorePro LED spot ND 4.4–35W MR16 827 36D		
CorePro LED spot ND 4.4–35W MR16 840 36D		
CorePro LED spot ND4.4–35W MR16 840 36DUK		
CorePro LED spot ND4.4–35W MR16 827 36DUK		

CorePro LEDspot LV

Dimensional drawing

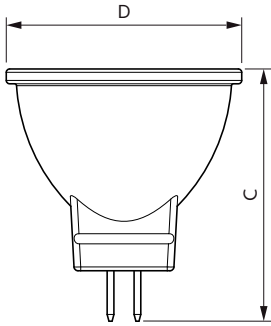

Product	D	C
CorePro LED spot 2.3-20W 827 MR11 36D	35.5 mm	39.5 mm

Controls and Dimming

Dimmable	No
----------	----

Operating and Electrical

Input Frequency	- Hz
Starting Time (Nom)	0.5 s

General Information

Switching Cycle	50000X
-----------------	--------

Light Technical

Beam Angle (Nom)	36 °
Color Rendering Index (Nom)	80
Llmf At End Of Nominal Lifetime (Nom)	70 %

Approval and Application

Order Code	Full Product Name	Energy Consumption kWh/1000 h
929001339201	LED 20W MR11 GU4 WW ND RF 1BC/6	3 kWh
929001339202	CorePro LED spot 2.6-20W 827 MR11 36D	3 kWh
929001339258	LED 20W MR11 GU4 WW ND 1SRT4	3 kWh
929001344002	CorePro LED spot ND 3-20W MR16 827 36D	3 kWh
929001344302	CorePro LED spot ND 5-35W MR16 827 36D	6 kWh
929001344352	CorePro LEDspot 5-35W MR16 827 36D 5CT	5 kWh
929001344502	CorePro LED spot ND 5-35W MR16 840 36D	6 kWh
929002494602	CorePro LED spot ND 4.4-35W MR16 827 36D	5 kWh
929002494652	CorePro LEDspot 4.4-35W MR16 827 36D 5CT	5 kWh
929002494699	CorePro LED spot ND4.4-35W MR16 827 36DUK	5 kWh

Order Code	Full Product Name	Energy Consumption kWh/1000 h
929002494702	CorePro LED spot ND 4.4-35W MR16 840 36D	5 kWh
929002494799	CorePro LED spot ND4.4-35W MR16 840 36DUK	5 kWh
929001904802	CorePro LED spot ND 7-50W MR16 827 36D	7 kWh
929001904902	CorePro LED spot ND 7-50W MR16 830 36D	7 kWh
929001905002	CorePro LED spot ND 7-50W MR16 840 36D	7 kWh
929002066402	CorePro LED spot 2.3-20W 827 MR11 36D	3 kWh
929002494502	CorePro LED spot ND 2.9-20W MR16 827 36D	3 kWh

Operating and Electrical

CorePro LEDspot LV

Order Code	Full Product Name	Voltage (Nom)	Wattage Equivalent	Power (Rated) (Nom)
929001339201	LED 20W MR11 GU4 WW ND RF 1BC/6	12 V	20 W	2.6 W
929001339202	CorePro LED spot 2.6-20W 827 MR11 36D	12 V	20 W	2.6 W
929001339258	LED 20W MR11 GU4 WW ND 1SR4	12 V	20 W	2.6 W
929001344002	CorePro LED spot ND 3-20W MR16 827 36D	12 V	20 W	3 W
929001344302	CorePro LED spot ND 5-35W MR16 827 36D	12 V	35 W	5 W
929001344352	CorePro LEDspot 5-35W MR16 827 36D 5CT	ac electronic 12 V	35 W	5 W
929001344502	CorePro LED spot ND 5-35W MR16 840 36D	12 V	35 W	5 W
929002494602	CorePro LED spot ND 4.4-35W MR16 827 36D	ac electronic 12 V	35 W	4.4 W
929002494652	CorePro LEDspot 4.4-35W MR16 827 36D 5CT	ac electronic 12 V	35 W	4.4 W

Order Code	Full Product Name	Voltage (Nom)	Wattage Equivalent	Power (Rated) (Nom)
929002494699	CorePro LED spot ND4.4-35W MR16 827 36DUK	ac electronic 12 V	35 W	4.4 W
929002494702	CorePro LED spot ND 4.4-35W MR16 840 36D	ac electronic 12 V	35 W	4.4 W
929002494799	CorePro LED spot ND4.4-35W MR16 840 36DUK	ac electronic 12 V	35 W	4.4 W
929001904802	CorePro LED spot ND 7-50W MR16 827 36D	12 V	50 W	7 W
929001904902	CorePro LED spot ND 7-50W MR16 830 36D	12 V	50 W	7 W
929001905002	CorePro LED spot ND 7-50W MR16 840 36D	12 V	50 W	7 W
929002066402	CorePro LED spot 2.3-20W 827 MR11 36D	ac electronic 12 V	20 W	2.3 W
929002494502	CorePro LED spot ND 2.9-20W MR16 827 36D	ac electronic 12 V	20 W	2.9 W

General Information

Order Code	Full Product Name	Cap-Base	Nominal Lifetime (Nom)
929001339201	LED 20W MR11 GU4 WW ND RF 1BC/6	GU4	15000 h
929001339202	CorePro LED spot 2.6-20W 827 MR11 36D	GU4	15000 h
929001339258	LED 20W MR11 GU4 WW ND 1SR4	GU4	15000 h
929001344002	CorePro LED spot ND 3-20W MR16 827 36D	GU5.3	15000 h
929001344302	CorePro LED spot ND 5-35W MR16 827 36D	GU5.3	15000 h
929001344352	CorePro LEDspot 5-35W MR16 827 36D 5CT	GU5.3	15000 h
929001344502	CorePro LED spot ND 5-35W MR16 840 36D	GU5.3	15000 h
929002494602	CorePro LED spot ND 4.4-35W MR16 827 36D	GU5.3	15000 h
929002494652	CorePro LEDspot 4.4-35W MR16 827 36D 5CT	GU5.3	15000 h

Order Code	Full Product Name	Cap-Base	Nominal Lifetime (Nom)
929002494699	CorePro LED spot ND4.4-35W MR16 827 36DUK	GU5.3	15000 h
929002494702	CorePro LED spot ND 4.4-35W MR16 840 36D	GU5.3	15000 h
929002494799	CorePro LED spot ND4.4-35W MR16 840 36DUK	GU5.3	15000 h
929001904802	CorePro LED spot ND 7-50W MR16 827 36D	GU5.3	15000 h
929001904902	CorePro LED spot ND 7-50W MR16 830 36D	GU5.3	15000 h
929001905002	CorePro LED spot ND 7-50W MR16 840 36D	GU5.3	15000 h
929002066402	CorePro LED spot 2.3-20W 827 MR11 36D	GU4	25000 h
929002494502	CorePro LED spot ND 2.9-20W MR16 827 36D	GU5.3	15000 h

Light Technical

Order Code	Full Product Name	Color Code	Correlated		
			Color Temperature (Nom)	Luminous Flux (Nom)	Luminous Intensity (Nom)
929001339201	LED 20W MR11 GU4 WW ND RF 1BC/6	827	2700 K	190 lm	400 cd

Order Code	Full Product Name	Color Code	Correlated		
			Color Temperature (Nom)	Luminous Flux (Nom)	Luminous Intensity (Nom)
929001339202	CorePro LED spot 2.6-20W 827 MR11 36D	827	2700 K	190 lm	400 cd

CorePro LEDspot LV

Order Code	Full Product Name	Correlated			
		Color Code	Color Temperature (Nom)	Luminous Flux (Nom)	Luminous Intensity (Nom)
929001339258	LED 20W MR11 GU4 WW ND 1SRT4	827	2700 K	190 lm	400 cd
929001344002	CorePro LED spot ND 3-20W MR16 827 36D	827	2700 K	230 lm	600 cd
929001344302	CorePro LED spot ND 5-35W MR16 827 36D	827	2700 K	345 lm	650 cd
929001344352	CorePro LEDspot 5-35W MR16 827 36D 5CT	827	2700 K	345 lm	650 cd
929001344502	CorePro LED spot ND 5-35W MR16 840 36D	840	4000 K	390 lm	650 cd
929002494602	CorePro LED spot ND 4.4-35W MR16 827 36D	827	2700 K	345 lm	650 cd
929002494652	CorePro LEDspot 4.4-35W MR16 827 36D 5CT	827	2700 K	345 lm	650 cd
929002494699	CorePro LED spot ND4.4-35W MR16 827 36DUK	827	2700 K	345 lm	650 cd

Order Code	Full Product Name	Correlated			
		Color Code	Color Temperature (Nom)	Luminous Flux (Nom)	Luminous Intensity (Nom)
929002494702	CorePro LED spot ND 4.4-35W MR16 840 36D	840	4000 K	390 lm	750 cd
929002494799	CorePro LED spot ND4.4-35W MR16 840 36DUK	840	4000 K	390 lm	750 cd
929001904802	CorePro LED spot ND 7-50W MR16 827 36D	827	2700 K	621 lm	1400 cd
929001904902	CorePro LED spot ND 7-50W MR16 830 36D	830	3000 K	621 lm	1400 cd
929001905002	CorePro LED spot ND 7-50W MR16 840 36D	840	4000 K	660 lm	1500 cd
929002066402	CorePro LED spot 2.3-20W 827 MR11 36D	827	2700 K	184 lm	400 cd
929002494502	CorePro LED spot ND 2.9-20W MR16 827 36D	827	2700 K	230 lm	560 cd

Mechanical and Housing

Order Code	Full Product Name	Bulb Shape
929001339201	LED 20W MR11 GU4 WW ND RF 1BC/6	MR11
929001339202	CorePro LED spot 2.6-20W 827 MR11 36D	MR11
929001339258	LED 20W MR11 GU4 WW ND 1SRT4	MR11
929001344002	CorePro LED spot ND 3-20W MR16 827 36D	MR16
929001344302	CorePro LED spot ND 5-35W MR16 827 36D	MR16
929001344352	CorePro LEDspot 5-35W MR16 827 36D 5CT	MR16
929001344502	CorePro LED spot ND 5-35W MR16 840 36D	MR16
929002494602	CorePro LED spot ND 4.4-35W MR16 827 36D	MR16
929002494652	CorePro LEDspot 4.4-35W MR16 827 36D 5CT	MR16

Order Code	Full Product Name	Bulb Shape
929002494699	CorePro LED spot ND4.4-35W MR16 827 36DUK	MR16
929002494702	CorePro LED spot ND 4.4-35W MR16 840 36D	MR16
929002494799	CorePro LED spot ND4.4-35W MR16 840 36DUK	MR16
929001904802	CorePro LED spot ND 7-50W MR16 827 36D	MR16
929001904902	CorePro LED spot ND 7-50W MR16 830 36D	MR16
929001905002	CorePro LED spot ND 7-50W MR16 840 36D	MR16
929002066402	CorePro LED spot 2.3-20W 827 MR11 36D	MR11
929002494502	CorePro LED spot ND 2.9-20W MR16 827 36D	MR16

Temperature

Order Code	Full Product Name	T-Case Maximum (Nom)
929001339201	LED 20W MR11 GU4 WW ND RF 1BC/6	79 °C
929001339202	CorePro LED spot 2.6-20W 827 MR11 36D	79 °C
929001339258	LED 20W MR11 GU4 WW ND 1SRT4	79 °C
929001344002	CorePro LED spot ND 3-20W MR16 827 36D	68 °C
929001344302	CorePro LED spot ND 5-35W MR16 827 36D	82 °C
929001344352	CorePro LEDspot 5-35W MR16 827 36D 5CT	82 °C
929001344502	CorePro LED spot ND 5-35W MR16 840 36D	82 °C
929002494602	CorePro LED spot ND 4.4-35W MR16 827 36D	85 °C
929002494652	CorePro LEDspot 4.4-35W MR16 827 36D 5CT	85 °C

Order Code	Full Product Name	T-Case Maximum (Nom)
929002494699	CorePro LED spot ND4.4-35W MR16 827 36DUK	85 °C
929002494702	CorePro LED spot ND 4.4-35W MR16 840 36D	85 °C
929002494799	CorePro LED spot ND4.4-35W MR16 840 36DUK	85 °C
929001904802	CorePro LED spot ND 7-50W MR16 827 36D	85 °C
929001904902	CorePro LED spot ND 7-50W MR16 830 36D	85 °C
929001905002	CorePro LED spot ND 7-50W MR16 840 36D	85 °C
929002066402	CorePro LED spot 2.3-20W 827 MR11 36D	60 °C
929002494502	CorePro LED spot ND 2.9-20W MR16 827 36D	75 °C

CorePro LEDspot LV

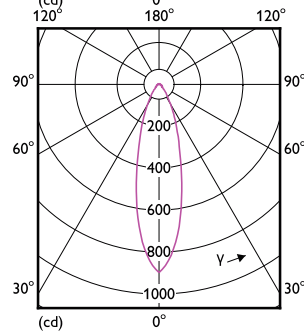
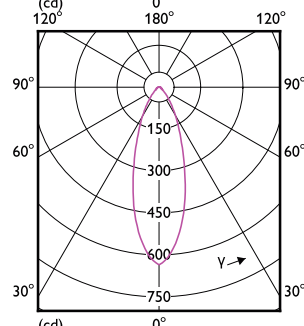
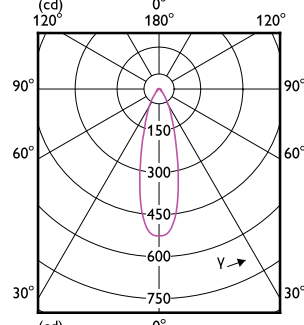
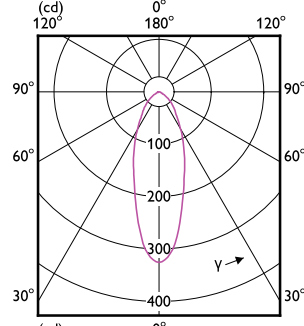
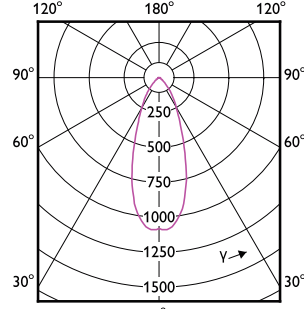
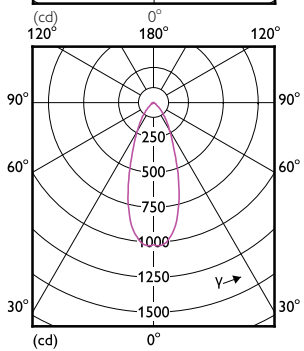
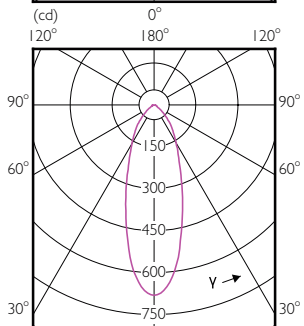
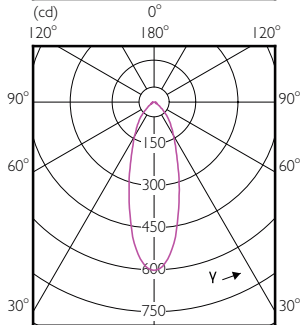
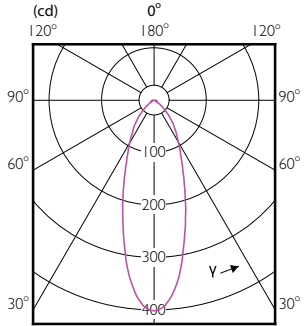
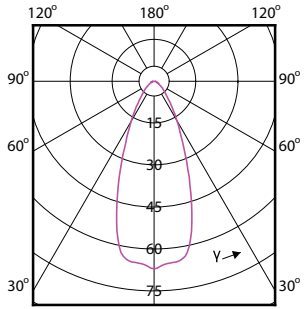

Accent Diagrams

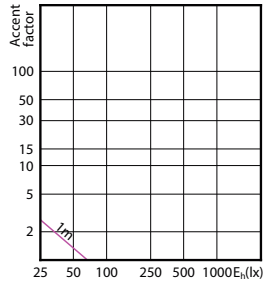

CorePro LEDspotLV 20W GU4 827 36D

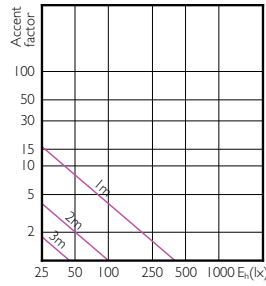

CorePro LEDspotLV 20W GU5-3 827 36D

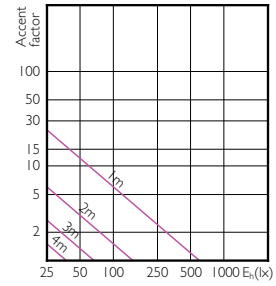

CorePro LEDspotLV 35W GU5-3 827 36D

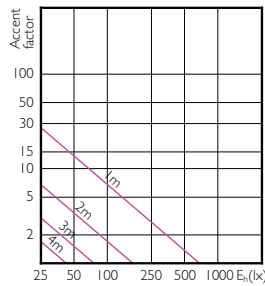

CorePro LEDspotLV 35W GU5-3 840 36D

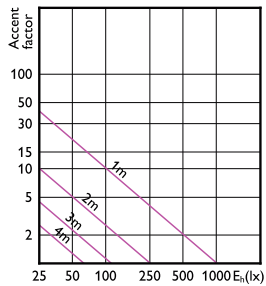

LEDspot Corepro 7-50W GU5.3 MR16 827 36D
ND

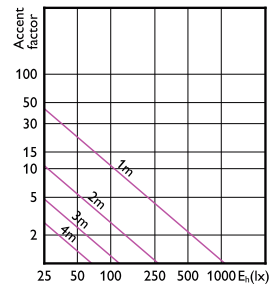

LEDspot MAS VLE 7-50W GU5.3 MR16 840 36D
DIM

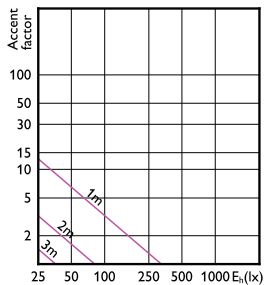

LEDspot Classic MR11 36D 2700K

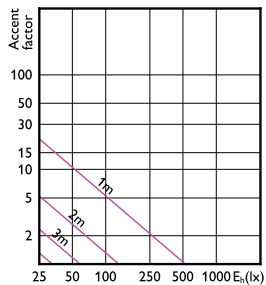

LEDspots Corepro SLR 2 2,9W MR16 GU5,3 827
36D-LA2

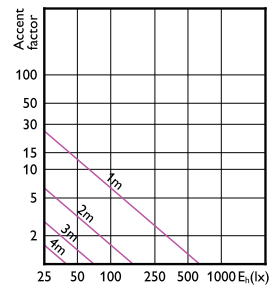

LEDspots Corepro SLR 2 4,4W MR16 GU5,3 827
36D-LA2

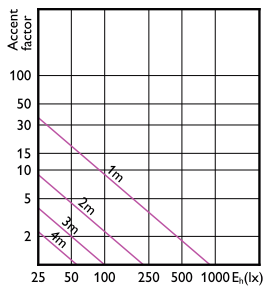

LEDspots Corepro SLR 2 4,4W MR16 GU5,3 840
36D-LA2

Beam Diagrams

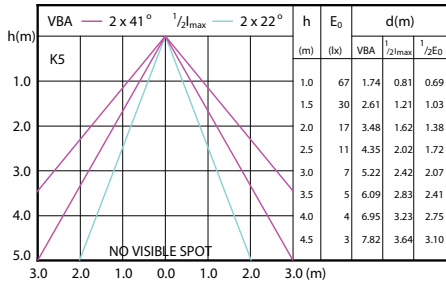

CorePro LEDspotLV 20W GU4 827 36D

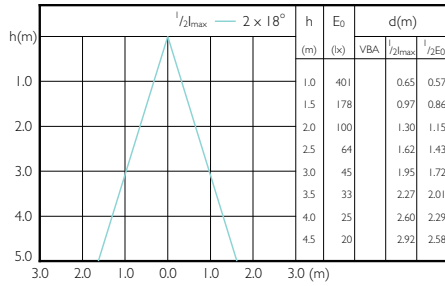

CorePro LEDspotLV 20W GU5-3 827 36D

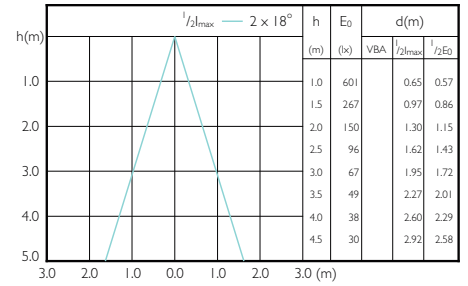

CorePro LEDspotLV 35W GU5-3 827 36D

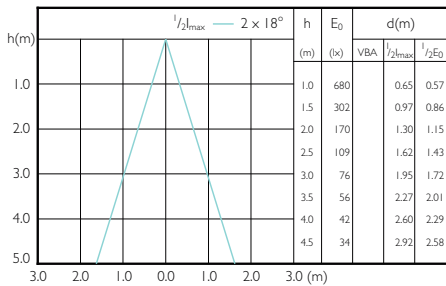

CorePro LEDspotLV 35W GU5-3 840 36D

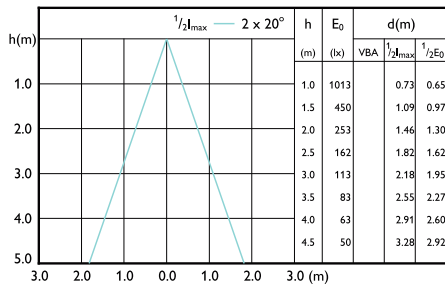

LEDspot Corepro 7-50W GU5.3 MR16 827 36D
ND

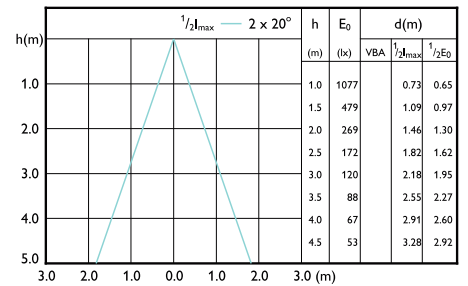

LEDspot MAS VLE 7-50W GU5.3 MR16 840 36D
DIM

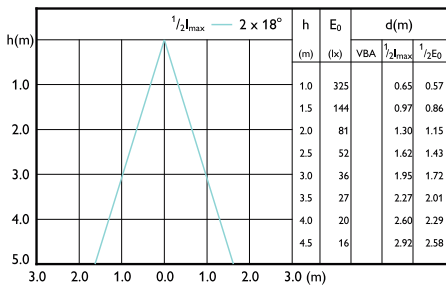

LEDspot Classic MR11 36D 2700K

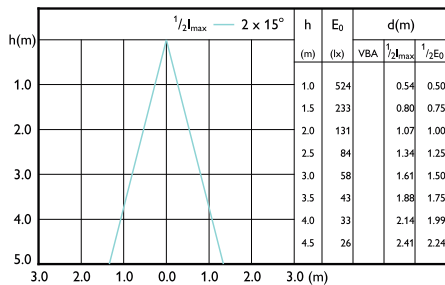

LEDspots Corepro SLR 2 2,9W MR16 GU5,3 827
36D-LBP

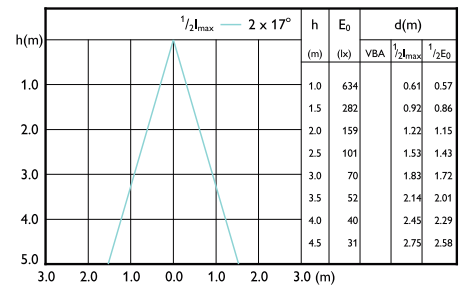

LEDspots Corepro SLR 2 4,4W MR16 GU5,3 827
36D-LBP

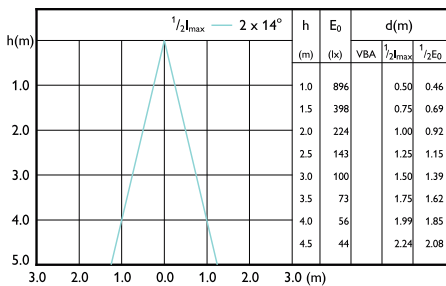

LEDspots Corepro SLR 2 4,4W MR16 GU5,3 840
36D-LBP

CorePro LEDspot LV

